

有关敝公司产品的注意事项

请务必在使用敝公司产品之前阅读。



注意

产品目录中的记载内容

本产品目录中所记载的内容为2021年1月的内容。因产品改良等原因，可能会不经预告而变更其记载内容，或是停止供应本产品目录中所记载的产品。所以，请务必在使用前先确认最新的产品信息。

未按照本产品目录中所记载的内容或交货规格说明书使用敝公司产品，即便其致使用设备发生损害、不良情况等时，敝公司也不承担任何责任，敬请知悉。

签署交货规格说明书

就本产品目录中所记载产品的产品规格等相关内容，敝公司备有交货规格说明书，详情请向敝公司咨询。在使用敝公司产品前请务必就交货规格说明书之内容确认并批准之。

实装前的事前评估

使用敝公司产品时，请务必事先安装到使用设备之后，在实际使用的环境下进行评估和确认。

用途的限定

1. 可以使用的设备

本产品目录中所记载的产品预设为使用于一般电子设备 [音像设备、办公自动化设备、家电产品、办公设备、信息通讯设备 (手机、电脑等)] 以及面向本产品目录或是交货规格说明书中另行注明的设备通用性、标准性用途。

另外，面向汽车用电子设备、电信基础设施 / 工业设备、医疗设备 (国际 (GHTF) 第一类、第二类、第三类) 方面的应用，敝公司也有预设的产品线，请参考本产品目录或是交货规格说明书的内容，使用相对应的产品。

2. 需要另行确认的设备

若考虑将本产品目录中所记载的产品使用于当产品发生故障、品质不良，或是由此引起的运转失常而可能会危及生命、身体或是财产，以及有可能给社会造成深刻影响的以下设备 (不包括本产品目录或是交货规格说明书中另行注明可以使用设备) 等时，请务必事先向敝公司咨询。

- (1) 运输用设备 (汽车驱动控制设备、火车控制设备、船舶控制设备等)
- (2) 交通信号设备
- (3) 防灾 / 保安设备
- (4) 医疗设备 (国际 (GHTF) 第三类)
- (5) 高公共性信息通讯设备 / 信息处理设备 (电话交换机、电话 / 无线 / 广播电视基站等)
- (6) 其他与上述设备有同等品质与可靠性要求的设备

3. 禁止使用的设备

请勿将敝公司产品使用于对安全性和可靠性有着极高要求的以下设备。

- (1) 航天设备 (人工卫星、火箭等)
- (2) 航空设备 ^(注释1)
- (3) 医疗设备 (国际 (GHTF) 第四类)、植体 (体内植入型) 医疗设备 ^(注释2)
- (4) 发电控制设备 (面向核能 / 水力 / 火力发电厂等的设备)
- (5) 海底设备 (海底中继设备、海中的作业设备等)
- (6) 军事设备
- (7) 其他与上述设备有同等品质与可靠性要求的设备

注释 1：仅限于对航空设备的安全运行不产生直接干扰的设备 [机内娱乐设备、机内照明设备、电动座椅、餐饮设备等]，在满足敝公司另行指定的相关条件时，亦可将敝公司产品用于以上用途。在贵公司考虑将敝公司的产品用于以上用途时，请务必事先向敝公司咨询相关的信息。

注释 2：包括注入人体内的部分和与此相连接的体外部分。

4. 责任的限制

未经敝公司的事先书面同意，把本产品目录中所记载的产品使用于非敝公司预设用途的设备、前述需要向敝公司咨询的设备或敝公司禁止使用的设备，从而给客户或第三方造成损害的，敝公司不承担任何责任，敬请知悉。

安全设计

需将敝公司的产品使用于对安全性和可靠性要求较高的设备、电路上时，请进行充分的安全性评估和可靠性评估。另外，请通过设置保护电路、保护装置的系统，设置冗余电路不会被单一故障影响安全性的系统等失效导向安全 (fail-safe) 设计，确保充分的安全性。

有关知识产权

本产品目录中所记载的信息是用于说明相关产品的典型操作以及相关应用。此类信息的使用不代表对于敝公司以及第三方的知识产权以及其他权利的使用许可或是不侵权保证。

保证范围

敝公司产品的保证范围仅限于已经交付的敝公司产品本身，由敝公司产品的故障或不良情况所诱发的损害，敝公司不承担任何责任，敬请知悉。但是，以书面形式另行签署了交易基本合同书、品质保证协定书等时，敝公司将根据该合同的条件提供保证。

正规销售渠道

本产品目录中所记载的内容适用于从敝公司营业所、销售子公司、销售代理店 (即“正规销售渠道”) 购买的敝公司产品，并不适用于从其他渠道购买的敝公司产品，敬请知悉。

出口时的注意事项

本产品目录中所记载的部分产品在出口时须事先确认《外汇和对外贸易法》以及美国在出口管理方面的相关法规，并办理相关手续。如有不明之处，请向敝公司咨询。

▶ 由于篇幅有限，本产品目录中只记载了有代表性的产品规格。若考虑使用敝公司产品时，请确认交货规格说明书中的详细规格。另外，有关各产品的详细信息 (特性图、可靠性信息、使用时的注意事项等)，请参阅敝公司网站 (<http://www.ty-top.com/>)。

陶瓷滤波器/分频器/耦合器/双路耦合器

回流焊

■ 型号标示法

F	Q	△	1	0	5	P	0	8	2	9	D	Z	-	T
①	②	③	④	⑤	⑥	⑦								

△=空格

① 类型

代码	类型
FI	高频滤波器
FQ	高频滤波器-高密度

② 端接类型

代码	端接类型
△	电镀

③ 尺寸

代码	尺寸 [mm]
212	2.0×1.25
168	1.6×0.8
105	1.0×0.5

④ 类别代码

代码	类别代码
B	带通型
L	低通型
H	高通型
D	双通型
C	平衡型
P	分频器
W	双路耦合器
K	耦合器

⑤ 频率

代码 (例)	频率 [MHz]
2450	2400~2500
0620	470~770

⑥ 规格代码

代码	规格代码
01~	个别规格

⑦ 包装

代码	包装
-T	卷盘带装

■ 外型尺寸 / 标准数量

<p>FI 212B Side 4Pins type</p>	<p>FI 212B LGA 3Pins type</p>	<p>FI 168B/L Side 4Pins type</p> <table border="1"> <thead> <tr> <th>A</th><th>数量</th></tr> </thead> <tbody> <tr> <td>FI 168B</td><td>0.5</td></tr> <tr> <td>FI 168L</td><td>0.45</td></tr> </tbody> </table>	A	数量	FI 168B	0.5	FI 168L	0.45	<p>FI 105B/L Side 4Pins type</p>
A	数量								
FI 168B	0.5								
FI 168L	0.45								
<p>FI 168L0628M4</p>	<p>FI 168L/H LGA 3Pins type</p>	<p>FI 168D type</p>	<p>FI 212C245033</p>						
<p>FI 212C245036</p>	<p>FI 212C245075</p>	<p>FI 168P Side 6Pins type</p>	<p>FI 168P Side 4Pins type</p>						

单位:mm

▶ 由于篇幅有限, 本产品目录中只记载了有代表性的产品规格, 若考虑使用公司产品时, 请确认交货规格说明书中的详细规格。另外, 有关各产品的详细信息(特性图、可靠性信息、使用时的注意事项等), 请参阅敝公司网站(<http://www.ty-top.com/>)。

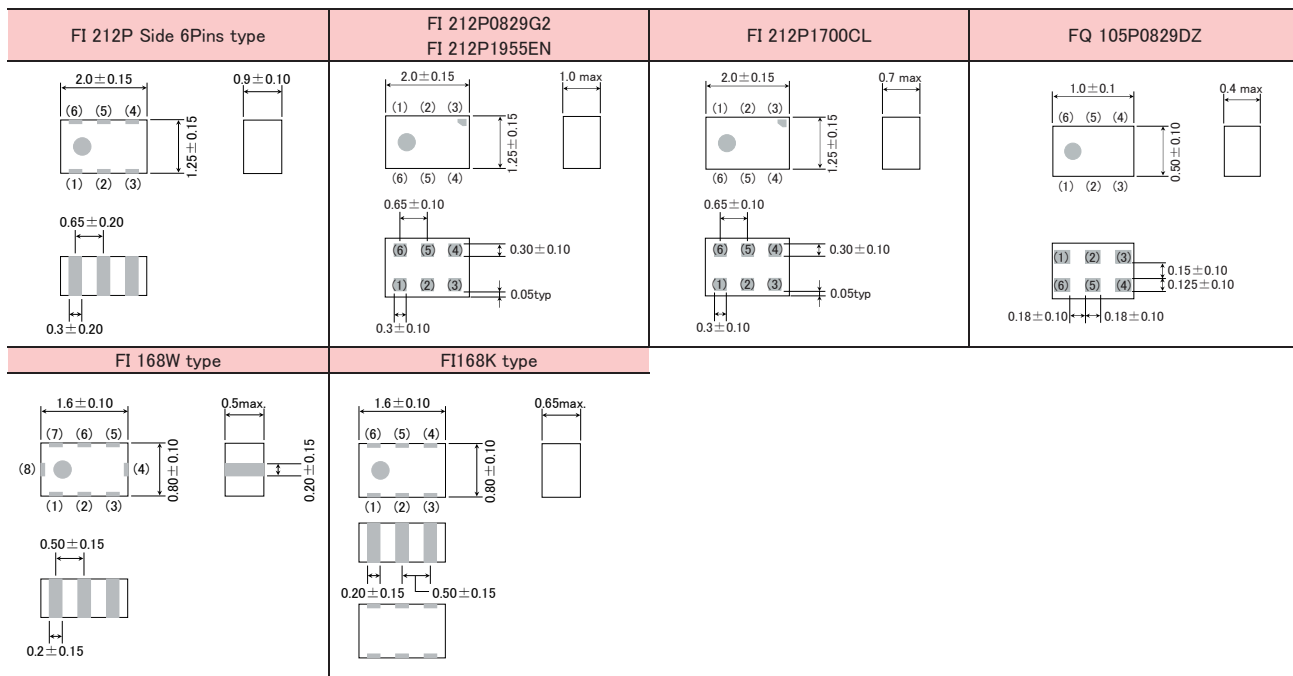

单位: mm

	FI 212B LGA 3Pins type	FI 168L0628M4	FI 168L/H LGA 3Pins type	FI 168D087018	FI 212C2450**	FI 168P245030
(1)	RF IN/OUT	I/O Port	RF IN/OUT	High Band IN	Balanced	GND
(2)	GND	GND	GND	GND	GND	Common
(3)	RF IN/OUT	I/O Port	RF IN/OUT	Low Band IN	Balanced	GND
(4)	-	GND	-	Low Band OUT	GND	Low Band
(5)	-	GND	-	GND	Unbalance	GND
(6)	-	GND	-	High Band OUT	DC	High Band
(7)	-	-	-	-	NC	-
(8)	-	-	-	-	GND	-

	FI 168P157519	FI 168P157525	FI 212P082931 FI 212P082934 FI 212P089208 FI 212P085912	FI 212P082935 FI 212P089213 FI 212P085909	FQ105P0829GZ FI 212P0829G2 FI 212P1700CL	FI 212P1955EN
(1)	GND	GND	Low Band	High Band	Low Band	GND
(2)	High Band	Low Band	GND	GND	GND	Common Port
(3)	Common	Common	High Band	Low Band	High Band	GND
(4)	Low Band	High Band	GND	GND	GND	High Band
(5)	-	-	Common Port	Common Port	Common Port	GND
(6)	-	-	GND	GND	GND	Low Band
(7)	-	-	-	-	-	-
(8)	-	-	-	-	-	-

	FI 168W type	FI 168K type
(1)	RF1 IN/OUT	COUPLING
(2)	CPL2 RF1	GND
(3)	CPL2 RF2	ISOLATION
(4)	GND	RF OUT
(5)	RF2 OUT/IN	GND
(6)	CPL1 RF2	RF IN
(7)	CPL1 RF1	-
(8)	GND	-

Type	标准数量[pcs]
212	3000~6000
168	4000~8000
105	10000

▶ 由于篇幅有限, 本产品目录中只记载了有代表性的产品规格, 若考虑使用敝公司产品时, 请确认交货规格说明书中的详细规格。另外, 有关各产品的详细信息(特性图、可靠性信息、使用时的注意事项等), 请参阅敝公司网站(<http://www.ty-top.com/>)。

■ 型号一览

● 陶瓷滤波器 带通型

用途	外型尺寸 [mm]	型号	注释
2.4GHz W-LAN / Bluetooth®	2.0 × 1.25 × 1.0max.	FI 212B245026	Side 4Pins
	2.0 × 1.25 × 1.0max.	FI 212B245027	Side 4Pins
	1.6 × 0.8 × 0.5max.	FI 168B245001	Side 4Pins
	1.0 × 0.5 × 0.4max.	FI 105B245024	Side 4Pins
5G NR Sub 6	2.0 × 1.25 × 0.65max.	FI 212B3750EQ	LGA 3Pins
	2.0 × 1.25 × 0.65max.	FI 212B4700DQ	LGA 3Pins

● 陶瓷滤波器 低通型

用途	外型尺寸 [mm]	型号	注释
Digital TV	1.6 × 0.8 × 0.45max.	FI 168L062005	Side 4Pins
2.4GHz W-LAN / Bluetooth®	1.0 × 0.5 × 0.4max.	FI 105L250014	Side 4Pins
	1.0 × 0.5 × 0.4max.	FI 105L186822	Side 4Pins
Cellular	1.0 × 0.5 × 0.4max.	FI 105L087038	Side 4Pins
	1.6 × 0.8 × 0.65max.	FI 168L0628M4	Side 6Pins
	1.6 × 0.8 × 0.65max.	FI 168L2200G9	LGA 3Pins
	1.6 × 0.8 × 0.65max.	FI 168L1681G6	LGA 3Pins

● 陶瓷滤波器 高通型

用途	外型尺寸 [mm]	型号	注释
Cellular	1.6 × 0.8 × 0.65max.	FI 168H2593GG	LGA 3Pins

用途	外型尺寸 [mm]	型号	注释
其他	1.6 × 0.8 × 0.45max.	FI 168D087018	Dual band LFP

● 陶瓷滤波器 平衡型

用途	外型尺寸 [mm]	型号	注释
Bluetooth®	2.0 × 1.25 × 1.0max.	FI 212C245033	Conjugated match to CSR BC3
	2.0 × 1.25 × 1.0max.	FI 212C245036	Conjugated match to CSR BC5
	2.0 × 1.25 × 0.7max.	FI 212C245075	Conjugated match to CSR BC5FM, BC6ROM

● 陶瓷滤波器 分频器

用途	外型尺寸 [mm]	型号	注释	
W-LAN	1.6 × 0.8 × 0.65max.	FI 168P245030	Side 6Pins	
	2.0 × 1.25 × 1.0max.	FI 212P082931	Side 6Pins	
Cellular 4G, 5G NR	2.0 × 1.25 × 1.0max.	FI 212P0829G2	LGA 6Pin	
	2.0 × 1.25 × 1.0max.	FI 212P082934	Side 6Pins	
	2.0 × 1.25 × 1.0max.	FI 212P082935	Side 6Pins	
	2.0 × 1.25 × 1.0max.	FI 212P089208	Side 6Pins	
	2.0 × 1.25 × 1.0max.	FI 212P089213	Side 6Pins	
	2.0 × 1.25 × 1.0max.	FI 212P085909	Side 6Pins	
	2.0 × 1.25 × 1.0max.	FI 212P085912	Side 6Pins	
	1.0 × 0.5 × 0.4max.	FQ 105P0829DZ	LGA 6Pin	
	2.0 × 1.25 × 1.0max.	FI 212P1955EN	LGA 6Pin	
	2.0 × 1.25 × 0.7max.	FI 212P1700CL	LGA 6Pin	
	GPS / 2.4GHz W-LAN	1.6 × 0.8 × 0.65max.	FI 168P157519	Side 4Pins
		1.6 × 0.8 × 0.65max.	FI 168P157525	Side 4Pins

● 陶瓷滤波器 耦合器

用途	外型尺寸 [mm]	型号	注释
Cellular	1.6 × 0.8 × 0.5max.	FI 168W1697B1	Side 8Pins
	1.6 × 0.8 × 0.5max.	FI 168K1687AA	Side 6Pins

▶ 由于篇幅有限，本产品目录中只记载了有代表性的产品规格，若考虑使用敝公司产品时，请确认交货规格说明书中的详细规格。另外，有关各产品的详细信息(特性图、可靠性信息、使用时的注意事项等)，请参阅敝公司网站(<http://www.ty-top.com/>)。

FI 212B245026

Pass band frequency	2400 - 2500 MHz
Insertion loss at pass band	2.6 dB max. (+25°C)
	2.9 dB max. (-40~+85°C)
Ripple at pass band	1.0 dB max.
V.S.W.R. at pass band	2.0 max.
Attenuation	40 dB min. (800 - 960 MHz)
	30 dB min. (1710 - 1990 MHz)
	25 dB min. (2110 - 2170 MHz)
	30 dB min. (4800 - 5000 MHz)
	30 dB min. (7200 - 7500 MHz)
Impedance	50 Ω

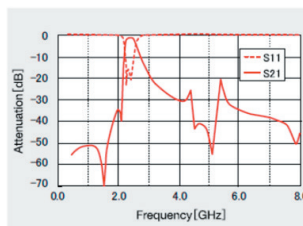

FI 212B245027

Pass band frequency	2400 - 2500 MHz
Insertion loss at pass band	1.4 dB max. (+25°C)
	1.7 dB max. (-40~+85°C)
Ripple at pass band	1.0 dB max.
V.S.W.R. at pass band	2.0 max.
Attenuation	30 dB min. (800 - 915 MHz)
	30 dB min. (1710 - 1910 MHz)
	6 dB min. (2110 - 2170 MHz)
	20 dB min. (4800 - 5000 MHz)

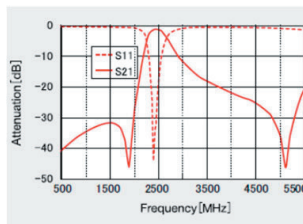

FI 168B245001

Pass band frequency	2400 - 2500 MHz
Insertion loss at pass band	2.2 dB max. (+25°C)
	2.5 dB max. (-30~+85°C)
Ripple at pass band	1.0 dB max.
V.S.W.R. at pass band	2.1 max.
Attenuation	25 dB min. (800 - 960 MHz)
	25 dB min. (1710 - 1910 MHz)
	20 dB min. (4800 - 5000 MHz)
	20 dB min. (7200 - 7500 MHz)
Impedance	50 Ω

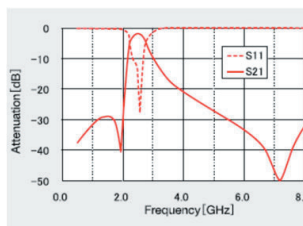

FI 105B245024

Pass band frequency	2400 - 2500 MHz
Insertion loss at pass band	3.0 dB max. (+25°C)
	3.3 dB max. (-40~+85°C)
Ripple at pass band	1.0 dB max.
V.S.W.R. at pass band	2.2 max.
Attenuation	25 dB min. (800 - 960 MHz)
	22 dB min. (1710 - 1910 MHz)
	20 dB min. (4800 - 5000 MHz)
	20 dB min. (7200 - 7500 MHz)

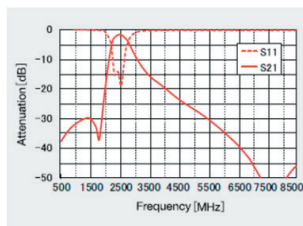

FI 212B3750EQ

Pass band frequency	3300 - 4200 MHz
Impedance	50 Ω

FI 212B4700DQ

Pass band frequency	4400 - 5000 MHz
Impedance	50 Ω

FI 168L062005

Pass band frequency	470 - 770 MHz
Insertion loss at 470 - 600 MHz	1.2 dB max. (+25°C)
	1.3 dB max. (-30~+85°C)
Insertion loss at 600 - 710 MHz	2.2 dB max. (+25°C)
	2.4 dB max. (-30~+85°C)
Insertion loss at 710 - 770 MHz	4.0 dB max. (+25°C)
	4.4 dB max. (-30~+85°C)
Ripple at 470 - 710 MHz	1.4 dB max.
V.S.W.R.	2.0 max. (470 - 710 MHz)
	2.5 max. (710 - 770 MHz)
Attenuation	25 dB min. (888 - 925 MHz) (+25°C)
	21 dB min. (888 - 925 MHz) (-30~+85°C)
	25 dB min. (940 - 960 MHz)
	27 dB min. (1429 - 1453 MHz)
	26 dB min. (1920 - 1980 MHz)
26 dB min. (2400 - 2500 MHz)	
Impedance	50 Ω

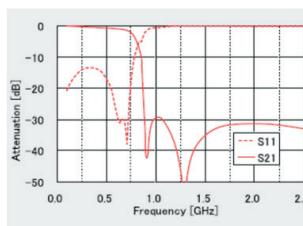

▶ 由于篇幅有限, 本产品目录中只记载了有代表性的产品规格, 若考虑使用贵公司产品时, 请确认交货规格说明书中的详细规格。另外, 有关各产品的详细信息(特性图、可靠性信息、使用时的注意事项等), 请参阅贵公司网站(<http://www.ty-top.com/>)。

FI 105L250014

Pass band frequency	2400 - 2500 MHz
Insertion loss at 2400 - 2500 MHz	0.45 dB max. (+25°C) 0.55 dB max. (-40~+85°C)
V.S.W.R. at 2400 - 2500 MHz	1.7 max.
Attenuation	21 dB min. (4800 - 5000 MHz) 21 dB min. (7200 - 7500 MHz)
Impedance	50 Ω

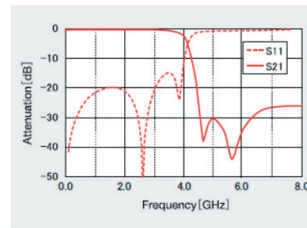

FI 105L186822

Pass band frequency	824 - 915 MHz
Insertion loss at 824 - 915 MHz	0.75 dB max. (-30~+85°C)
V.S.W.R. at 2400 - 2500 MHz	1.5 max.
Attenuation	23 dB min. (1648 - 1830 MHz) 23 dB min. (2472 - 2745 MHz)
Impedance	50 Ω

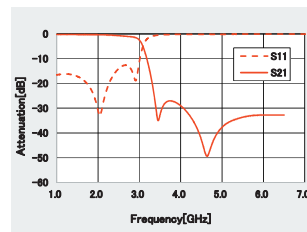

FI 105L087038

Pass band frequency	824 - 915 MHz
Insertion loss at 824 - 915 MHz	0.75 dB max. (-30~+85°C)
V.S.W.R. at 2400 - 2500 MHz	1.5 max.
Attenuation	23 dB min. (1648 - 1830 MHz) 23 dB min. (2472 - 2745 MHz)
Impedance	50 Ω

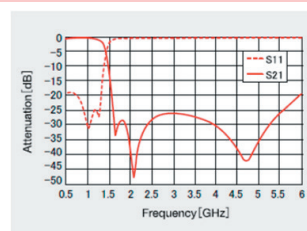

FI 168L0628M4

Pass band frequency	470 - 787 MHz
Insertion loss at pass band	0.5 dB max. (+25°C) 0.6 dB max. (-40~+90°C)
Ripple at pass band	-
V.S.W.R. at pass band	2.0 max.
Attenuation	26 dB min. (1429 - 1501 MHz) 30 dB min. (1565 - 1607 MHz) 35 dB min. (1570 - 1580 MHz) 18 dB min. (1920 - 1980 MHz)
Impedance	50 Ω

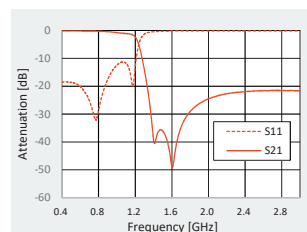

FI 168L2200G9

Pass band frequency	1700 - 2170 MHz 2170 - 2500 MHz 2500 - 2700 MHz
Insertion loss at 1700 - 2170 MHz	0.5 dB max. (+25°C) 0.55 dB max. (-30~+85°C)
Insertion loss at 2170 - 2500 MHz	0.65 dB max. (+25°C) 0.75 dB max. (-30~+85°C)
Insertion loss at 2500 - 2700 MHz	0.9 dB max. (+25°C) 1.0 dB max. (-30~+85°C)
Return loss. at 1700 - 2700 MHz	10 dB min.
Attenuation	25 dB min. (3400 MHz) 22 dB min. (3400 - 5400 MHz) 20 dB min. (5400 - 8100 MHz)
Impedance	50 Ω

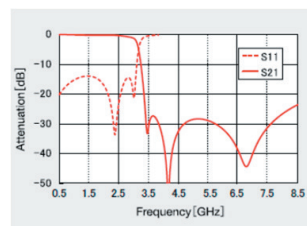

FI 168L1681G6

Pass band frequency	617 - 2690 MHz
Return loss. at 617 - 2690 MHz	0.5 dB max. (-40~+90°C) 10 dB min.
Attenuation	35 dB min. (4950 - 6000 MHz) 35 dB min. (6000 - 7500 MHz) 35 dB min. (7500 - 8100 MHz) 35 dB min. (8100 - 10500 MHz) 27 dB min. (10500 - 12500 MHz)
Impedance	50 Ω

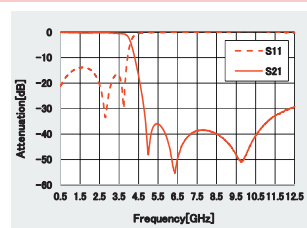

▶ 由于篇幅有限，本产品目录中只记载了有代表性的产品规格，若考虑使用敝公司产品时，请确认交货规格说明书中的详细规格。另外，有关各产品的详细信息(特性图、可靠性信息、使用时的注意事项等)，请参阅敝公司网站(<http://www.ty-top.com/>)。

FI 168H2593GG

Pass band frequency	2496 - 2690 MHz
Insertion loss at 2500 - 2700 MHz	0.9 dB max. (-40~+90°C)
Return loss. at 1700 - 2700 MHz	15 dB min.
Attenuation	25 dB min. (1710 - 1995 MHz)
Impedance	50 Ω

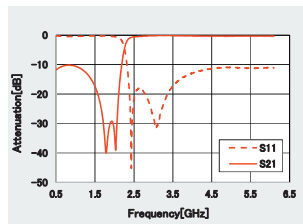

FI 168D087018

Low band	
Pass band frequency	824 - 915 MHz
Insertion loss at 824 - 915 MHz	0.6 dB max. (-30~+85°C)
V.S.W.R. at 824 - 915 MHz	1.5 max.
Attenuation	25 dB min. (1648 - 1830 MHz) 25 dB min. (2472 - 2745 MHz)
Impedance	50 Ω

High band	
Pass band frequency	1710 - 1910 MHz
Insertion loss at 1710 - 1910 MHz	0.6 dB max. (-30~+85°C)
V.S.W.R. at 824 - 915 MHz	1.5 max.
Attenuation	25 dB min. (3420 - 3820 MHz) 25 dB min. (5130 - 5730 MHz)
Impedance	50 Ω
Isolation	
In to In/Out to Out	27 dB min. (824 - 915 MHz) 30 dB min. (1710 - 1910 MHz)
In to Out	30 dB min. (824 - 915 MHz) 30 dB min. (1710 - 1910 MHz)

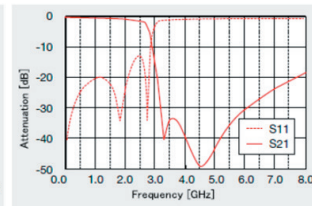
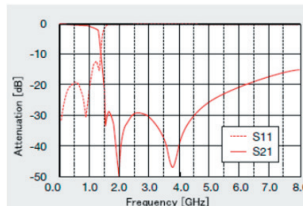

FI 212C245033

Pass band frequency	2400 - 2500 MHz
Insertion loss at pass band	2.7 dB (+25°C) 3.0 dB (-30~+85°C)
Ripple at pass band	1.0 dB max.
Unbalanced port V.S.W.R. at pass band	2.0 max.
Balanced port V.S.W.R. at pass band	2.0 max.
Amplitude Imbalance at pass band	2.0 dB max.
Phase Imbalance at pass band	180 ± 10°C
Attenuation	25 dB min. (880 - 960 MHz) 15 dB min. (1710 - 1990 MHz) 15 dB min. (1990 - 2170 MHz) 15 dB min. (4800 - 5000 MHz)
Unbalanced port Impedance	50 Ω
Balanced port Impedance	Conjugated match to CSR BC3

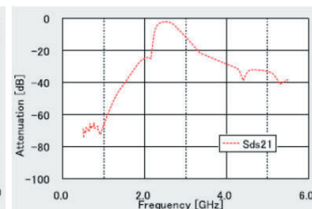
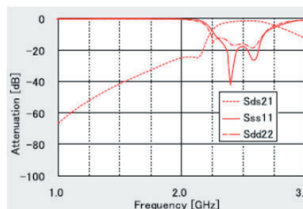

FI 212C245036

Pass band frequency	2400 - 2500 MHz
Insertion loss at pass band	3.7 dB (+25°C) 4.0 dB (-30~+85°C)
Ripple at pass band	1.0 dB max.
Unbalanced port V.S.W.R. at pass band	2.0 max.
Balanced port V.S.W.R. at pass band	2.0 max.
Amplitude Imbalance at pass band	2.0 dB max.
Phase Imbalance at pass band	180 ± 10°C
Attenuation	35 dB min. (880 - 960 MHz) 20 dB min. (1710 - 1990 MHz) 15 dB min. (1990 - 2170 MHz) 20 dB min. (4800 - 5000 MHz)
Unbalanced port Impedance	50 Ω
Balanced port Impedance	Conjugated match to CSR BC5

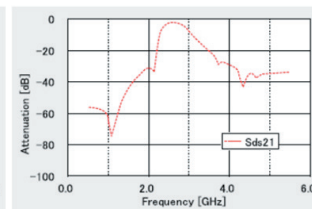
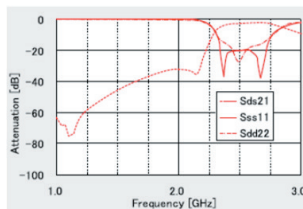

FI 212C245075

Pass band frequency	2400 - 2500 MHz
Insertion loss at pass band	3.7 dB (+25°C) 4.0 dB (-30~+85°C)
Ripple at pass band	1.0 dB max.
Unbalanced port V.S.W.R. at pass band	2.2 max.
Balanced port V.S.W.R. at pass band	2.2 max.
Amplitude Imbalance at pass band	2.0 dB max.
Phase Imbalance at pass band	180 ± 10°C
Attenuation	40 dB min. (880 - 960 MHz) 18 dB min. (1710 - 1990 MHz) 12 dB min. (1990 - 2170 MHz) 30 dB min. (4800 - 5000 MHz)
Unbalanced port Impedance	50 Ω
Balanced port Impedance	Conjugated match to CSR BC5FM, BC6ROM

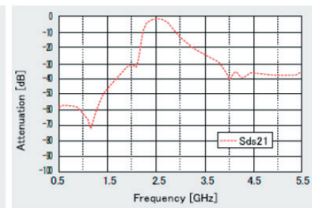
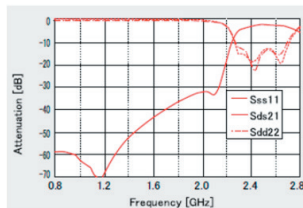

▶ 由于篇幅有限，本产品目录中只记载了有代表性的产品规格，若考虑使用贵公司产品时，请确认交货规格说明书中的详细规格。另外，有关各产品的详细信息(特性图、可靠性信息、使用时的注意事项等)，请参阅贵公司网站(<http://www.ty-top.com/>)。

射频元器件

FI 168P245030

Low band

Pass band frequency 1	1558 - 1610 MHz
Pass band frequency 2	2400 - 2500 MHz
Insertion loss at Pass band 1	0.50 dB max.
Insertion loss at Pass band 2	0.60 dB max.
V.S.W.R. at Pass band	2.0 dB max.
Attenuation	24 dB min. (4800 - 4900 MHz)
	26 dB min. (4900 - 6000 MHz)
Impedance	50 Ω

High band

Pass band frequency	4900 - 5950 MHz
Insertion loss at Pass band	0.80 dB max.
V.S.W.R. at Pass band	2.0 dB max.
Attenuation	32 dB min. (30 - 2700 MHz)
Impedance	50 Ω

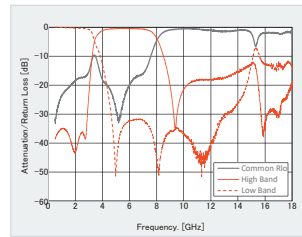

FI 212P082931

Low band

Pass band frequency 1	698 - 894 MHz
Pass band frequency 2	880 - 960 MHz
Insertion loss at 698 - 894 MHz	0.50 dB max. (+25°C)
	0.60 dB max. (-40~+85°C)
Insertion loss at 880 - 960 MHz	0.70 dB max. (+25°C)
	0.80 dB max. (-40~+85°C)
V.S.W.R. at 698 - 894 MHz	2.0 max.
V.S.W.R. at 880 - 960 MHz	2.0 max.
Attenuation	13 dB min. (1420 - 2690 MHz)
Impedance	50 Ω

High band

Pass band frequency 1	1420 - 1520 MHz
Pass band frequency 2	1560 - 1610 MHz
Pass band frequency 3	1710 - 2170 MHz
Pass band frequency 4	2300 - 2690 MHz
Insertion loss at 1420 - 1520 MHz	0.70 dB max. (+25°C)
	0.80 dB max. (-40~+85°C)
Insertion loss at 1560 - 1610 MHz	0.50 dB max. (+25°C)
	0.60 dB max. (-40~+85°C)
Insertion loss at 1710 - 2170 MHz	0.50 dB max. (+25°C)
	0.60 dB max. (-40~+85°C)
Insertion loss at 2300 - 2690 MHz	0.50 dB max. (+25°C)
	0.60 dB max. (-40~+85°C)
V.S.W.R. at 1420 - 2690 MHz	2.0 max.
Attenuation	13 dB min. (698 - 960 MHz)
Impedance	50 Ω

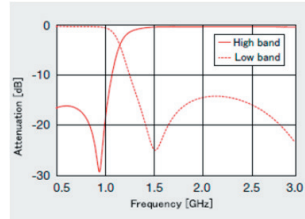

FI 212P0829G2

Low band

Pass band frequency	698 - 960 MHz
Insertion loss at 698 - 960 MHz	0.27 dB max. (+25°C)
	0.32 dB max. (-40~+85°C)
V.S.W.R. at 698 - 960 MHz	2.0 max.
Attenuation	13 dB min. (1710 - 2690 MHz)
Impedance	50 Ω

High band

Pass band frequency	1710 - 2690 MHz
Insertion loss at 1710 - 2690 MHz	0.45 dB max. (+25°C)
	0.55 dB max. (-40~+85°C)
V.S.W.R. at 698 - 960 MHz	2.0 max.
Attenuation	19 dB min. (698 - 960 MHz)
Impedance	50 Ω

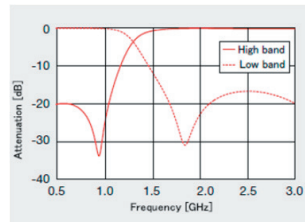

FI 212P082934

Low band

Pass band frequency	698 - 960 MHz
Insertion loss at 698 - 960 MHz	0.50 dB max. (-40~+85°C)
V.S.W.R. at 698 - 960 MHz	1.4 max.
Attenuation	15 dB min. (1554 - 1580 MHz)
	25 dB min. (1710 - 2110 MHz)
	25 dB min. (2110 - 2155 MHz)
	12 dB min. (2155 - 2690 MHz)
Impedance	50Ω

High band

Pass band frequency 1	1710 - 2170 MHz
Pass band frequency 2	2500 - 2690 MHz
Insertion loss at 1710 - 2170 MHz	0.50 dB max. (-40~+85°C)
Insertion loss at 2500 - 2690 MHz	0.55 dB max. (-40~+85°C)
V.S.W.R. at 1710 - 2170 MHz	1.4 max.
V.S.W.R. at 2500 - 2690 MHz	1.8 max.
Attenuation	17 dB min. (0.3 - 960 MHz)
Impedance	50Ω

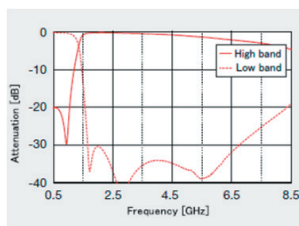

FI 212P082935

Low band

Pass band frequency	698 - 960 MHz
Insertion loss at 698 - 960 MHz	0.50 dB max. (-40~+85°C)
V.S.W.R. at 698 - 960 MHz	1.4 max.
Attenuation	15 dB min. (1554 - 1580 MHz)
	25 dB min. (1710 - 2110 MHz)
	25 dB min. (2110 - 2155 MHz)
	12 dB min. (2155 - 2690 MHz)
Impedance	50Ω

High band

Pass band frequency 1	1710 - 2170 MHz
Pass band frequency 2	2500 - 2690 MHz
Insertion loss at 1710 - 2170 MHz	0.50 dB max. (-40~+85°C)
Insertion loss at 2500 - 2690 MHz	0.55 dB max. (-40~+85°C)
V.S.W.R. at 1710 - 2170 MHz	1.4 max.
V.S.W.R. at 2500 - 2690 MHz	1.8 max.
Attenuation	17 dB min. (0.3 - 960 MHz)
Impedance	50Ω

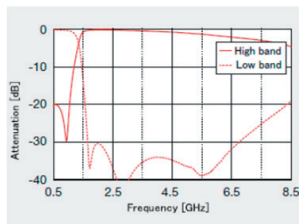

FI 212P089208

Low band

Pass band frequency	698 - 960 MHz
Insertion loss at 698 - 960 MHz	0.27 dB max. (+25°C)
	0.32 dB max. (-40~+85°C)
V.S.W.R. at 698 - 960 MHz	2.0 max.
Attenuation	13 dB min. (1710 - 2170 MHz)
Impedance	50Ω

High band

Pass band frequency	1710 - 2170 MHz
Insertion loss at 1710 - 2170 MHz	0.45 dB max. (+25°C)
	0.55 dB max. (-40~+85°C)
V.S.W.R. at 698 - 960 MHz	2.0 max.
Attenuation	19 dB min. (698 - 960 MHz)
Impedance	50Ω

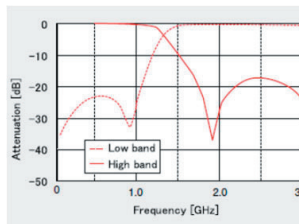

FI 212P089213

Low band

Pass band frequency	698 - 960 MHz
Insertion loss at 698 - 960 MHz	0.27 dB max. (+25°C)
	0.32 dB max. (-40~+85°C)
V.S.W.R. at 698 - 960 MHz	2.0 max.
Attenuation	13 dB min. (1710 - 2170 MHz)
Impedance	50Ω

High band

Pass band frequency	1710 - 2170 MHz
Insertion loss at 1710 - 2170 MHz	0.45 dB max. (+25°C)
	0.55 dB max. (-40~+85°C)
V.S.W.R. at 698 - 960 MHz	2.0 max.
Attenuation	19 dB min. (698 - 960 MHz)
Impedance	50Ω

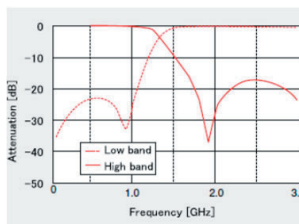

▶ 由于篇幅有限，本产品目录中只记载了有代表性的产品规格，若考虑使用敝公司产品时，请确认交货规格说明书中的详细规格。另外，有关各产品的详细信息(特性图、可靠性信息、使用时的注意事项等)，请参阅敝公司网站(<http://www.ty-top.com/>)。

FI 212P085909

Low band	
Pass band frequency	698 – 960 MHz
Insertion loss at 698 – 960 MHz	0.70 dB max. (+25°C) 0.75 dB max. (-30~+85°C)
V.S.W.R. at 698 – 960 MHz	1.6 max.
Attenuation	19 dB min. (1558 – 1570 MHz) 20 dB min. (1570 – 1580 MHz) 19 dB min. (1580 – 1610 MHz)
Impedance	50 Ω
High band	
Pass band frequency 1	1558 – 1570 MHz
Pass band frequency 2	1570 – 1580 MHz
Pass band frequency 3	1580 – 1610 MHz
Insertion loss at 1558 – 1570 MHz	0.75 dB max. (+25°C) 0.85 dB max. (-30~+85°C)
Insertion loss at 1570 – 1580 MHz	0.70 dB max. (+25°C) 0.80 dB max. (-30~+85°C)
Insertion loss at 1580 – 1610 MHz	0.70 dB max. (+25°C) 0.80 dB max. (-30~+85°C)
V.S.W.R. at 1558 – 1570 MHz	1.6 max.
V.S.W.R. at 1570 – 1580 MHz	1.6 max.
V.S.W.R. at 1580 – 1610 MHz	1.6 max.
Attenuation	35 dB min. (698 – 824 MHz) 42 dB min. (824 – 894 MHz) 25 dB min. (894 – 960 MHz)
Impedance	50 Ω

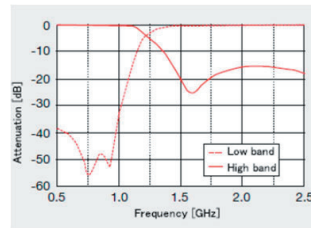

FI 212P085912

Low band	
Pass band frequency	698 – 960 MHz
Insertion loss at 698 – 960 MHz	0.70 dB max. (+25°C) 0.75 dB max. (-30~+85°C)
V.S.W.R. at 698 – 960 MHz	1.6 max.
Attenuation	19 dB min. (1558 – 1570 MHz) 20 dB min. (1570 – 1580 MHz) 19 dB min. (1580 – 1610 MHz)
Impedance	50 Ω
High band	
Pass band frequency 1	1558 – 1570 MHz
Pass band frequency 2	1570 – 1580 MHz
Pass band frequency 3	1580 – 1610 MHz
Insertion loss at 1558 – 1570 MHz	0.75 dB max. (+25°C) 0.85 dB max. (-30~+85°C)
Insertion loss at 1570 – 1580 MHz	0.70 dB max. (+25°C) 0.80 dB max. (-30~+85°C)
Insertion loss at 1580 – 1610 MHz	0.70 dB max. (+25°C) 0.80 dB max. (-30~+85°C)
V.S.W.R. at 1558 – 1570 MHz	1.6 max.
V.S.W.R. at 1570 – 1580 MHz	1.6 max.
V.S.W.R. at 1580 – 1610 MHz	1.6 max.
Attenuation	35 dB min. (698 – 824 MHz) 42 dB min. (824 – 894 MHz) 25 dB min. (894 – 960 MHz)
Impedance	50 Ω

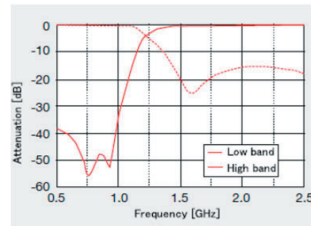

FQ 105P0829DZ

Pass band frequency 1	699 – 960 MHz
Pass band frequency 2	1710 – 2690 MHz
Impedance	50 Ω

FI 212P1955EN

Pass band frequency 1	1427 – 2200 MHz
Pass band frequency 2	2496 – 5000 MHz
Impedance	50 Ω

FI 212P1700CL

Pass band frequency 1	699 – 2690 MHz
Pass band frequency 2	3300 – 5000 MHz
Impedance	50 Ω

FI 168P157519

Low band

Pass band frequency 0	824 - 960 MHz
Pass band frequency 1	1558 - 1585 MHz
Pass band frequency 2	1585 - 1610 MHz
Insertion loss at 824 - 960 MHz	0.50 dB max. (+25°C)
	0.60 dB max. (-40~+85°C)
Insertion loss at 1558 - 1585 MHz	0.40 dB max. (+25°C)
	0.50 dB max. (-40~+85°C)
Insertion loss at 1585 - 1610 MHz	0.45 dB max. (+25°C)
	0.55 dB max. (-40~+85°C)
V.S.W.R. at 824 - 960 MHz	2.0 max.
V.S.W.R. at 1558 - 1585 MHz	2.0 max.
V.S.W.R. at 1585 - 1610 MHz	2.0 max.
Attenuation	13 dB min. (2400 - 2500 MHz)
Impedance	50 Ω

High band

Pass band frequency	2400 - 2500 MHz
Insertion loss at 2400 - 2500 MHz	0.60 dB max. (+25°C)
	0.70 dB max. (-40~+85°C)
V.S.W.R. at 2400 - 2500 MHz	2.0 max.
Attenuation	12 dB min. (824 - 960 MHz)
	23 dB min. (1558 - 1585 MHz)
	20 dB min. (1585 - 1610 MHz)
Impedance	50 Ω

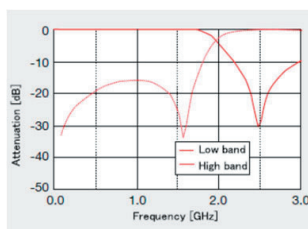

FI 168P157525

Low band

Pass band frequency 0	824 - 960 MHz
Pass band frequency 1	1558 - 1585 MHz
Pass band frequency 2	1585 - 1610 MHz
Insertion loss at 824 - 960 MHz	0.50 dB max. (+25°C)
	0.60 dB max. (-40~+85°C)
Insertion loss at 1558 - 1585 MHz	0.40 dB max. (+25°C)
	0.50 dB max. (-40~+85°C)
Insertion loss at 1585 - 1610 MHz	0.45 dB max. (+25°C)
	0.55 dB max. (-40~+85°C)
V.S.W.R. at 824 - 960 MHz	2.0 max.
V.S.W.R. at 1558 - 1585 MHz	2.0 max.
V.S.W.R. at 1585 - 1610 MHz	2.0 max.
Attenuation	13 dB min. (2400 - 2500 MHz)
Impedance	50 Ω

High band

Pass band frequency	2400 - 2500 MHz
Insertion loss at 2400 - 2500 MHz	0.60 dB max. (+25°C)
	0.70 dB max. (-40~+85°C)
V.S.W.R. at 2400 - 2500 MHz	2.0 max.
Attenuation	12 dB min. (824 - 960 MHz)
	23 dB min. (1558 - 1585 MHz)
	12 dB min. (1585 - 1610 MHz)
Impedance	50 Ω

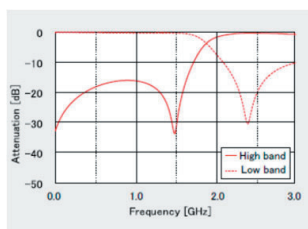

FI 168W1697B1

Pass band frequency	699 - 2690 MHz
Insertion loss at 699 - 960 MHz	0.15 dB max. (+35~+85°C)
	0.1 dB max. (+15~+35°C)
	0.1 dB max. (-20~+15°C)
Insertion loss at 1000 - 2025 MHz	0.25 dB max. (+35~+85°C)
	0.2 dB max. (+15~+35°C)
	0.2 dB max. (-20~+15°C)
Insertion loss at 2110 - 2690 MHz	0.38 dB max. (+35~+85°C)
	0.28 dB max. (+15~+35°C)
	0.28 dB max. (-20~+15°C)
Ripple	0.1 dB max. (699 - 746 MHz)
	0.1 dB max. (791 - 862 MHz)
	0.1 dB max. (824 - 960 MHz)
	0.1 dB max. (1710 - 2170 MHz)
	0.1 dB max. (2500 - 2690 MHz)
RF Coupling	28.1~29.5 dB (699MHz)
	25.8~27.2 dB (915MHz)
	20.7~22.1 dB (1710MHz)
	19.9~21.3 dB (1880MHz)
	19.3~20.7 dB (2025MHz)
	18.3~19.7 dB (2300MHz)
	17.1~18.5 dB (2690MHz)
Coupling ration mismatch between Coupler branch 1 and Coupler branch 2	-1~1 dB (699 - 2690 MHz)
Directivity	18 dB min. (699 - 2690 MHz)
Impedance	50 Ω

▶ 由于篇幅有限, 本产品目录中只记载了有代表性的产品规格, 若考虑使用敝公司产品时, 请确认交货规格说明书中的详细规格。另外, 有关各产品的详细信息(特性图、可靠性信息、使用时的注意事项等), 请参阅敝公司网站(<http://www.ty-top.com/>)。

FI 168K1687AA

Pass band frequency	698 - 2690 MHz
Insertion loss at 699 - 2690 MHz	0.25 dB max. (+25°C)
	0.30 dB max. (-40~+85°C)
S11 Coupled port at 698 - 2690 MHz	0.25 dB max. (+25°C)
RF Coupling	26.5~29.0 dB (698MHz)
	24.0~27.0 dB (915MHz)
	21.5~24.5 dB (1710MHz)
	21.5~24.5 dB (2025MHz)
	21.5~24.5 dB (2300MHz)
	21.5~25.5 dB (2690MHz)
Isolation	35 dB min. (698 - 2690 MHz)
Impedance	50 Ω

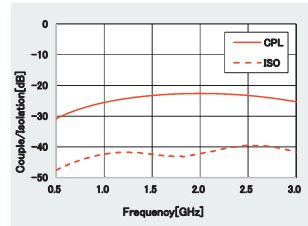

MULTILAYER CERAMIC DEVICES / DIPLEXERS / COUPLER / 2 BRANCH COUPLER

PACKAGING

① Minimum Quantity

Type	Embossed tape / Paper tape [pcs]
212B-1.0	3000
212C	
212P-1.0	
168B	4000
168L	
168D	
168P	
168L-G	5000
168H	
168P245030	
212B-0.65	
212P-0.7	
168W	8000
168K	
105B	
105L	10000
105P	

② Tape Material

● Embossed Tape

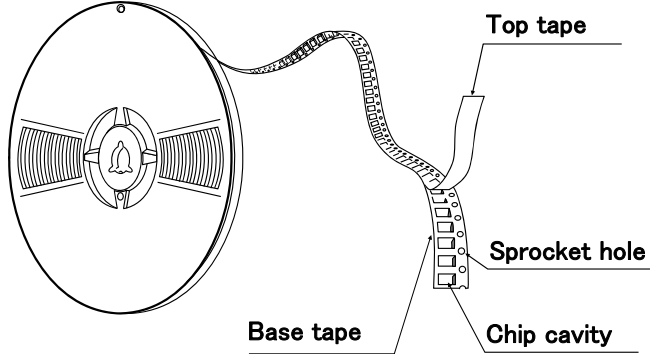

● Card Board Carrier Tape

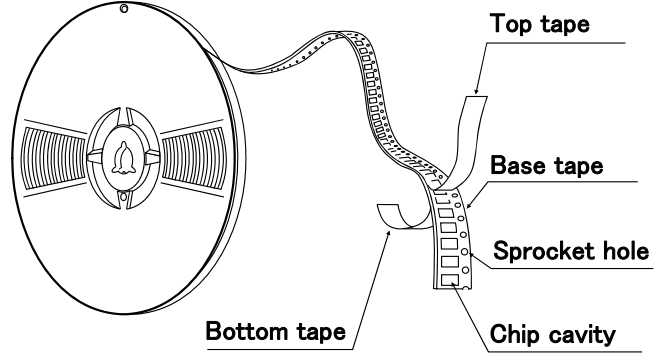

Chip Filled

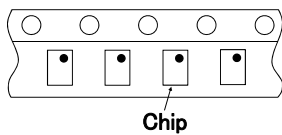

③ Taping Dimensions

● Embossed tape 0.315 inches wide

Unit: mm (inch)

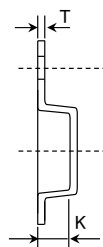
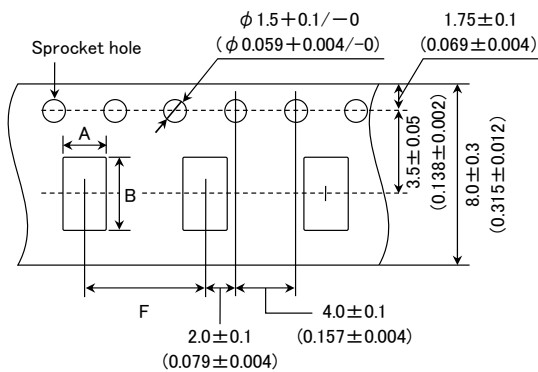

▶ This catalog contains the typical specification only due to the limitation of space. When you consider the purchase of our products, please check our specification. For details of each product (characteristics graph, reliability information, precautions for use, and so on), see our Web site (<http://www.ty-top.com/>).

Type	Chip cavity		Insertion Pitch	Tape Thickness max.	
	A	B	F	K	T
212B-1.0	1.45±0.2 (0.057±0.008)	2.25±0.2 (0.089±0.008)	4.0±0.1 (0.157±0.004)	1.1 Max (0.043 Max)	0.3 (0.012)
212B-0.65	1.45±0.2 (0.057±0.008)	2.25±0.2 (0.089±0.008)	4.0±0.1 (0.157±0.004)	0.95 Max (0.037 Max)	0.3 (0.012)
212C	1.45±0.2 (0.057±0.008)	2.25±0.2 (0.089±0.008)	4.0±0.1 (0.157±0.004)	1.1 Max (0.043 Max)	0.3 (0.012)
212C-0.7	1.45±0.2 (0.057±0.008)	2.25±0.2 (0.089±0.008)	4.0±0.1 (0.157±0.004)	0.95 Max (0.037 Max)	0.3 (0.012)
212P-1.0	1.45±0.2 (0.057±0.008)	2.25±0.2 (0.089±0.008)	4.0±0.1 (0.157±0.004)	1.1 Max (0.043 Max)	0.3 (0.012)
212P-0.7	1.45±0.2 (0.057±0.008)	2.25±0.2 (0.089±0.008)	4.0±0.1 (0.157±0.004)	0.95 Max (0.037 Max)	0.3 (0.012)

Unit : mm (inch)

● Paper tape 0.315 inches wide

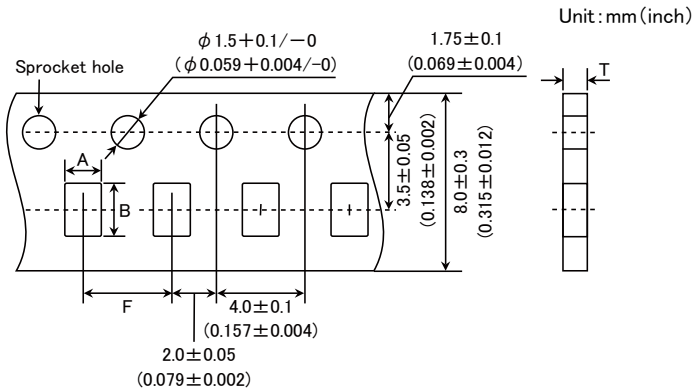

Type	Chip cavity		Insertion Pitch	Tape Thickness max.
	A	B	F	T
168B	1.00±0.05 (0.039±0.002)	1.80±0.05 (0.071±0.002)	4.0±0.1 (0.157±0.004)	0.55 (0.022)
168L	1.00±0.05 (0.039±0.002)	1.80±0.05 (0.071±0.002)	4.0±0.1 (0.157±0.004)	0.55 (0.022)
168W	1.00±0.05 (0.039±0.002)	1.80±0.05 (0.071±0.002)	4.0±0.1 (0.157±0.004)	0.55 (0.022)
168K	1.00±0.05 (0.039±0.002)	1.80±0.05 (0.071±0.002)	4.0±0.1 (0.157±0.004)	0.80 (0.031)
168D	1.00±0.05 (0.039±0.002)	1.80±0.05 (0.071±0.002)	4.0±0.1 (0.157±0.004)	0.55 (0.022)
168P	0.95±0.05 (0.037±0.002)	1.80±0.05 (0.071±0.002)	4.0±0.1 (0.157±0.004)	0.80 (0.031)
168L-G	0.95±0.05 (0.037±0.002)	1.80±0.05 (0.071±0.002)	4.0±0.1 (0.157±0.004)	0.80 (0.031)
168H	0.95±0.05 (0.037±0.002)	1.80±0.05 (0.071±0.002)	4.0±0.1 (0.157±0.004)	0.80 (0.031)
105B	0.62±0.03 (0.024±0.001)	1.12±0.03 (0.044±0.001)	2.0±0.05 (0.079±0.002)	0.45 (0.018)
105L	0.62±0.03 (0.024±0.001)	1.12±0.03 (0.044±0.001)	2.0±0.05 (0.079±0.002)	0.45 (0.018)
105P	0.62±0.03 (0.024±0.001)	1.12±0.03 (0.044±0.001)	2.0±0.05 (0.079±0.002)	0.45 (0.018)

Unit : mm (inch)

④ Leader and Blank Portion

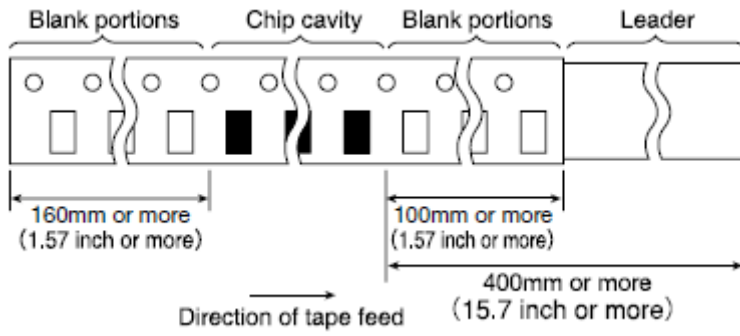

⑤ Reel size

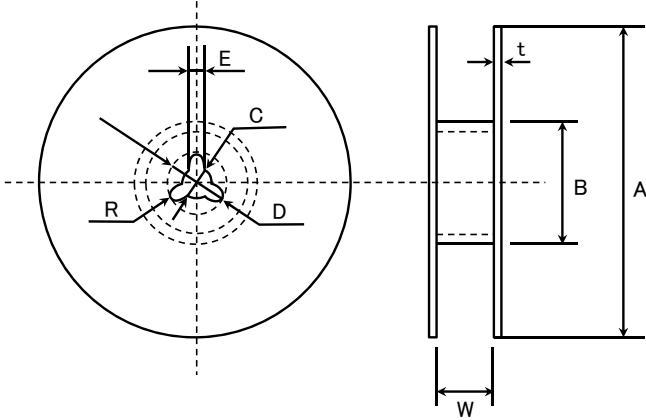

A	B	C	D	E	R
$\phi 178 \pm 2.0$ ($\phi 7.01 \pm 0.079$)	$\phi 50 \text{ min.}$ ($\phi 1.97 \text{ min.}$)	$\phi 13.0 \pm 0.2$ ($\phi 0.512 \pm 0.008$)	$\phi 21.0 \pm 0.8$ ($\phi 0.827 \pm 0.031$)	2.0 ± 0.5 (0.079 ± 0.020)	1.0
	t	W			
8mm width tape (0.315 inches width)	2.5max. (0.098max.)	10 ± 1.5 (0.394 ± 0.059)			
12mm width tape (0.472 inches width)	2.5max. (0.098max.)	14 ± 1.5 (0.551 ± 0.059)			

Unit: mm (inch)

⑥ Top Tape Strength

The top tape requires a peel-off force of 0.1~0.7N in the direction of the arrow as illustrated below.

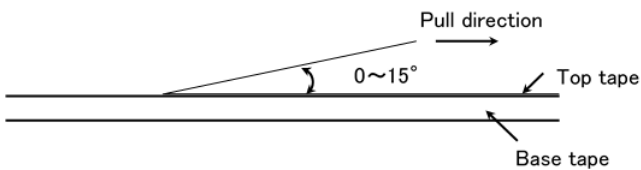

MULTILAYER CERAMIC DEVICES / DIPLEXERS / COUPLER / 2 BRANCH COUPLER

RELIABILITY DATA

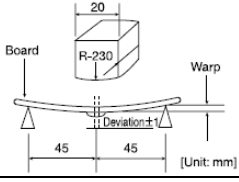
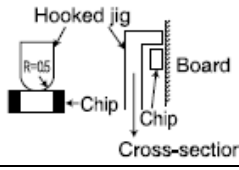
1. Operating Temperature Range	
Specified Value	-40~+85°C
2. Storage Temperature Range	
Specified Value	-40~+85°C
Test Methods and Remarks	※Note : -20 to +40°C in taped packaging
3. Resistance to Flexure of Substrate	
Specified Value	No mechanical damage.
Test Methods and Remarks	<p>Warp : 2mm Testing board : Glass epoxy-resin substrate Thickness : 0.8mm</p>  <p>[Unit: mm]</p>
4. Adhesion of Electrode	
Specified Value	Characteristics : shall satisfy the electrical characteristics. Appearance : No significant abnormality.
Test Methods and Remarks	<p>Applied force : 5N Duration : 10 sec.</p>  <p>Cross-section</p>
5. Solderability	
Specified Value	75% or more of immersed surface of terminal electrode shall be covered with fresh solder.
Test Methods and Remarks	<p>Solder temperature : 240±5°C Duration : 3±1 sec Preconditioning : Immersion into flux. Immersion and Removal speed : 25mm/sec.</p>
6. Resistance to Solder Heat	
Specified Value	Characteristics : shall satisfy the electrical characteristics. Appearance : No significant abnormality.
Test Methods and Remarks	<p>Preheating : 150°C for 2 min. Solder temperature : 260±5°C Duration : 5±0.5 sec. Preconditioning : Immersion into flux. Immersion and Removal speed : 25mm/sec. Recovery : 2 to 3hrs of recovery under the standard condition after the removal from test chamber.</p>

▶ This catalog contains the typical specification only due to the limitation of space. When you consider the purchase of our products, please check our specification. For details of each product (characteristics graph, reliability information, precautions for use, and so on), see our Web site (<http://www.ty-top.com/>).

7. Thermal Shock																
Specified Value	Characteristics : shall satisfy the electrical characteristics. Appearance : No significant abnormality.															
Test Methods and Remarks	According to JIS C60068-2-14. Conditions for 1 cycle															
	<table border="1"> <thead> <tr> <th>Step</th> <th>Temperature (°C)</th> <th>Duration (min)</th> </tr> </thead> <tbody> <tr> <td>1</td> <td>-40±3</td> <td>30±3</td> </tr> <tr> <td>2</td> <td>Room Temperature</td> <td>Within 3</td> </tr> <tr> <td>3</td> <td>85±2</td> <td>30±3</td> </tr> <tr> <td>4</td> <td>Room Temperature</td> <td>Within 3</td> </tr> </tbody> </table>	Step	Temperature (°C)	Duration (min)	1	-40±3	30±3	2	Room Temperature	Within 3	3	85±2	30±3	4	Room Temperature	Within 3
	Step	Temperature (°C)	Duration (min)													
	1	-40±3	30±3													
	2	Room Temperature	Within 3													
3	85±2	30±3														
4	Room Temperature	Within 3														
Number of cycles : 100																
Mounting method : Soldering onto PC board.																
Recovery : 2 to 3hrs of recovery under the standard condition after the removal from test chamber.																

8. Humidity (steady state)	
Specified Value	Characteristics : shall satisfy the electrical characteristics. Appearance : No significant abnormality.
Test Methods and Remarks	Temperature : +85±2°C Humidity : 85±5%RH Duration : 1000 hrs Recovery : 2 to 3hrs of recovery under the standard condition after the removal from test chamber.

9. High temperature life test	
Specified Value	Characteristics : shall satisfy the electrical characteristics. Appearance : No significant abnormality.
Test Methods and Remarks	Temperature : +85±2°C Duration : 1000 hrs Recovery : 2 to 3hrs of recovery under the standard condition after the removal from test chamber.

10. Low temperature life test	
Specified Value	Characteristics : shall satisfy the electrical characteristics. Appearance : No significant abnormality.
Test Methods and Remarks	Temperature : -40±2°C Duration : 1000 hrs Recovery : 2 to 3hrs of recovery under the standard condition after the removal from test chamber.

Note on standard condition:

“standard condition” referred to herein is defined as follows :
5 to 35°C of temperature, 45 to 85% relative humidity and 86 to 106kPa of air pressure.

When there are questions concerning measurement result :

In order to provide correlation data, the test shall be conducted under condition of 20±2°C of temperature, 60 to 70% relative humidity and 86 to 106kPa of air pressure.

Unless otherwise specified, all the tests are conducted under the “standard condition”.

MULTILAYER CERAMIC DEVICES / DIPLEXERS / COUPLER / 2 BRANCH COUPLER

PRECAUTIONS

1. PCB Design

◆ Land pattern design

Land pattern dimension examples

Technical considerations

FI 212B Side 4Pins type	FI 212B LGA 3Pins type	FI 168B/L Side 4Pins type	FI 105B/L Side 4Pins type
Unit: mm	Unit: mm	Unit: mm	Unit: mm
FI 168L/FI 168P/FI 168D/FI 168K Side 4Pins type	FI 168L/H LGA Type	FI 212C Type	FI 168P Side 4Pins type
Unit: mm	Unit: mm	Unit: mm	Unit: mm
FI 212P Side 6Pins type	FI 212P LGA 6Pins Type	FQ 105P Type	FI 168W Type
Unit: mm	Unit: mm	Unit: mm	Unit: mm

2. Soldering

◆ Conditions for Reflow soldering (for reference)

- Pb Free Reflow Profile

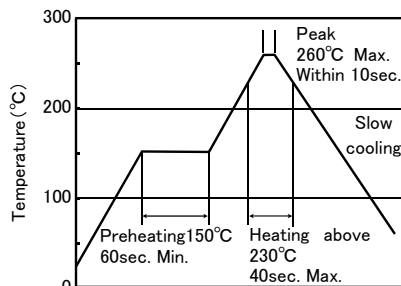

- ※ Components should be preheated to within 100 to 130°C from soldering temperature.
- ※ Assured to be reflow soldering for 2 times.

Note : The above profiles are the maximum allowable soldering condition, therefore these profiles are not always recommended.

3. Storage conditions

Precautions	<p>◆Storage conditions</p> <ol style="list-style-type: none">1. The Products must not be used in the following environments :<ul style="list-style-type: none">• exposure to special gases such as (C12, NH3, SOx, NOx)• exposure to volatile gas or inflammable gas• exposure to a lot of dust• exposure to water or condensation• exposure to direct sunlight or freezing2. The Products should be kept in the following conditions :<ul style="list-style-type: none">• Temperature : $-10\sim+40^{\circ}\text{C}$• Humidity : 15~85%RH max.3. The products should be used within 6 months after delivery. In case of storage over 6 months, solderability shall be checked before actual usage.
-------------	---

- Please contact of our offices for further details of specifications.
All of the standard values listed here are subject to change without notice.
Therefore, please check the specifications carefully before use.